

# USE MANUAL

English



**ELECTRIC SCISSORS  
MOD. OPTIMA 702**



dal 1946

ED.1-09/13

Rasor® Elettromeccanica S.r.l. was established in Milan in 1946 by Luigi Spinelli. For more than sixty years it has been producing automatic cutting systems, cutting units for textile applications and electric and pneumatic cutters.



dal 1946

Initially considered as a point of reference for cutting systems in the textile applications, the Rasor® products are nowadays widely used in other fields: chemical, automotive, nautical and sport sectors and in furniture manufacturing.

Rasor® can rely on the professional continuity of three generations, thanks to the precious support of the promoting partner, to his passion, dedication and great experience of seventy years.

The main characteristic of Rasor® is that each working phase, starting from the manufacturing of the product up to its packing and delivery, is carried out in Rasor® premises by qualified operators who have professionally grown up following the spirit of the company and of its founders. This ensures the high quality which Rasor® has always considered as essential since the beginning of its activity.

Following the innovative spirit mentioned above, our company is constantly focused on the improvement of the product quality, on the study and development of new materials and technologies.

## ACKNOWLEDGMENT

Dear Customer,

thank you for choosing a Rasor® Elettromeccanica S.r.l. product.

Rasor® has been a reference point in the field of cutting systems in the textile, clothing, furniture, tailoring, sport, chemical, automotive, nautical and insulating material sectors for years. Its production has been always synonymous with reliability attested by many of satisfied customers.

Rasor® quality system supervises all the company activities in order to provide the Customer with a service that meets its needs and expectations in terms of product quality, delivery reliability and stock of finished products.

All the parts of the devices have been planned and produced to guarantee an optimum performance. In order to keep the high quality level and the long reliability of the Rasor® products, it is recommended using only original spare parts and to contact the head office for any maintenance work.

## 1. GENERAL SAFETY RULES



This manual is an integral part of electric scissors OPTIMA 702 and must be carefully read before using it, since it gives important indications with regards to its safe installation, use and maintenance. Keep it with care.



Before using electric scissors OPTIMA 702, read carefully the following general safety rules.

EN  
19

- **PACKAGING.**  
After taking off the packaging make sure that the electric scissors are intact. In case of doubt do not use them and contact an authorized service centre. Do not leave pieces of packaging (plastic bags, foam polystyrene, boxes, etc.) within the reach of children or disabled persons, since they are potential sources of danger.
- **AVOID DANGEROUS ENVIRONMENTS.**  
Prevent the electric scissors OPTIMA 702 components from coming in contact with damp or wet surfaces.
- **KEEP CHILDREN AWAY.**  
Unauthorized persons, in particular children, must be kept away from the working area.
- **FEED CABLE.**  
Prevent the feed cable from coming in contact with hot objects, pointed surfaces or sharp edges. Never pull the feed cable of the machine. It must never be replaced by the user. If necessary contact professionally qualified staff.
- **KEEP THE WORKING AREA ALWAYS IN ORDER.**  
The workplace must always be kept in order and well lightened; liquids or oil traces must not be present.
- **ALWAYS USE ELECTRIC SCISSORS OPTIMA 702 PROPERLY.**  
Use the electric scissors only to carry out the works they have been designed for; do not use them improperly.
- **OBSERVE THE USE OF THE TOOLS.**  
Do not cut excessively thick materials and always check blade conditions.
- **AVOID ACCIDENTAL STARTINGS.**  
Before connecting electric scissors OPTIMA 702, make sure that everything is installed properly.
- **CLOTHING.**  
Do not use large clothes or accessories that might get stuck in the moving parts.
- **GOGGLES AND PROTECTIVE METAL MESH GLOVES.**  
Always use goggles, protective metal mesh gloves approved by Rasor® during use and maintenance operations (according to UNI EN 388:2004 standard).
- **SPARE PARTS.**  
During maintenance and replacement operations use only original spare parts. Blade maintenance must be only performed by Rasor® technicians.
- **INSTALLATION.**  
Any installation that is not in conformity with these specifications could jeopardize your safety and cancels the warranty.



dal 1946

## Informative letter

The installer and the maintenance man must know the content of this manual. Although the main features of the equipment described in this manual are not subject to change, **Rasor® Elettromeccanica S.r.l.** reserves the right to modify the components, details and accessories it deems necessary to improve the product or to meet manufacturing or commercial requirements at any time and without being obliged to update this manual immediately.

EN  
20



**WARNING**



### **ALL RIGHTS ARE RESERVED ACCORDING TO THE INTERNATIONAL COPYRIGHT CONVENTIONS,**

The reproduction of any part of this manual, in any form, is forbidden without the prior written authorization of Rasor® Elettromeccanica S.r.l.

The content of this guide can be modified without prior notice. Great care has been taken in collecting and checking the documentation contained in this manual to make it as complete and comprehensible as possible.

Nothing contained in this manual can be considered as a warranty, either expressed or implied - including, not in a restrictive way, the suitability warranty for any special purpose. Nothing contained in this manual can be interpreted as a modification or confirmation of the terms of any purchase contract.

Rasor® Elettromeccanica S.r.l. products have not been conceived to work in areas at risk of explosions and at high risk of fire and they cannot cut wet or damp materials. Moreover, they cannot work in case of rain.

In case of damage or malfunction, electric scissors OPTIMA 702 must not be used until the Customer Care Technical Service has repaired them.

### **Customer Care Technical Service**



dal 1946

For any information, please contact  
RASOR®ELETTROMECCANICAS.r.l.  
Via V. Caldesi, 6; 20161, MILANO (MI) - ITALY  
Phone: +39.02.66221231; Fax: +39.02.66221293  
e-mail: [info@rasor-cutters.com](mailto:info@rasor-cutters.com)  
web: [www.rasor-cutters.com](http://www.rasor-cutters.com)

### **WARNING**



The original configuration of the electric scissors must not be changed at all. On receiving them, make sure the supply corresponds to what has been ordered. In case of non-compliance immediately inform Rasor®. Also make sure the scissors have not been damaged during transport.



dal 1946

## 2. TRANSPORT AND PACKING

The electric scissors are delivered in a carrying case, inside which there are various options. The code of the ordered product and its serial number are indicated outside the package (see picture 1). The following accessories are contained in a bag inside the carrying case:

- 1) Quadrangular blade (4 sides);
- 2) Grease tube;
- 3) Drift for blade assembly/disassembly;
- 4) Brushes for electric motor;
- 5) Fuse 1.25 A;
- 6) Butterfly wrench for blade nut disassembly.

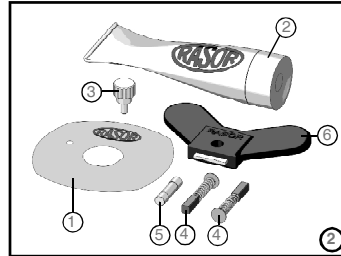
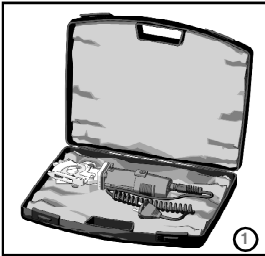

## 3. PLATE DATA

The manufacturer's identification and EC STANDARD 2006/42/EC conformity plate (see picture below) is located on the front part of the electric scissors.

**The plate must not be removed at all, even if the equipment is resold. Always refer to the serial number (written on the plate itself) when contacting the manufacturer.**

Several safety warnings are printed on a card which is applied to the scissors feeding cable; such warnings must be strictly followed by everyone dealing with the equipment. **The company is not to be held responsible for damage to property or accidents to people which might occur if the above-mentioned warnings are not observed. In such a case, the operator is the only person responsible.**

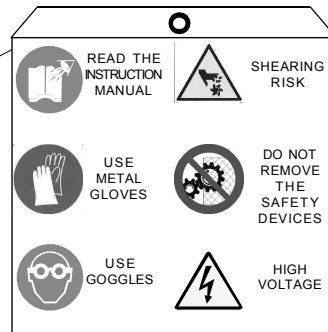
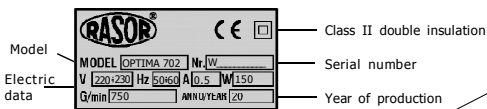

## 4. PRODUCT DESCRIPTION

This manual describes electric scissors model OPTIMA 702 which are used in order to quickly cut fabrics in the textile industry and other materials. They are extremely versatile, light and precise in the cutting operation. Thanks to the use of a supporting front foot and of an effective cutting system with quadrangular blade, it is possible to use the electric scissors to cut different materials. In particular the scissors have been designed to cut difficult materials such as moquettes, polymeric materials, fiber glass, insulations and leather (even hide).

EN  
22

One special feature of electric scissors OPTIMA 702 is their ability to sharpen the blade in each moment, without disassembling it, by means of a grinding wheel mounted on the scissors head. After carrying out this operation, it is possible to immediately start cutting again. A high power motor, perfectly balanced, with a high number of revolutions and totally free of maintenance, reduces the vibrations to the minimum. For this reason the electric scissors comply with Legislative Decree n. 187 dated 19/8/2005, which adopts European Directive n. 2002/44/EC concerning the risks deriving from mechanical vibrations.

The mechanical parts are made of high-quality steel, bronze and aluminium and require lubrication after several working hours.

Device components

1	Enabling push button	10	Sharpening button
2	Spiral cable gland	11	Front protection guard
3	Spiral feeding cable	12	Motor support
4	Two-pole Contur plug	13	Motor casing
5	Steel foot	14	Back protection guard
6	Steel polygonal blade	15	Reference point
7	Greaser	16	Carbide counterblade
8	Brush holder cap	17	Plate locking the threads
9	Emery grinding wheel	18	Fuse cover

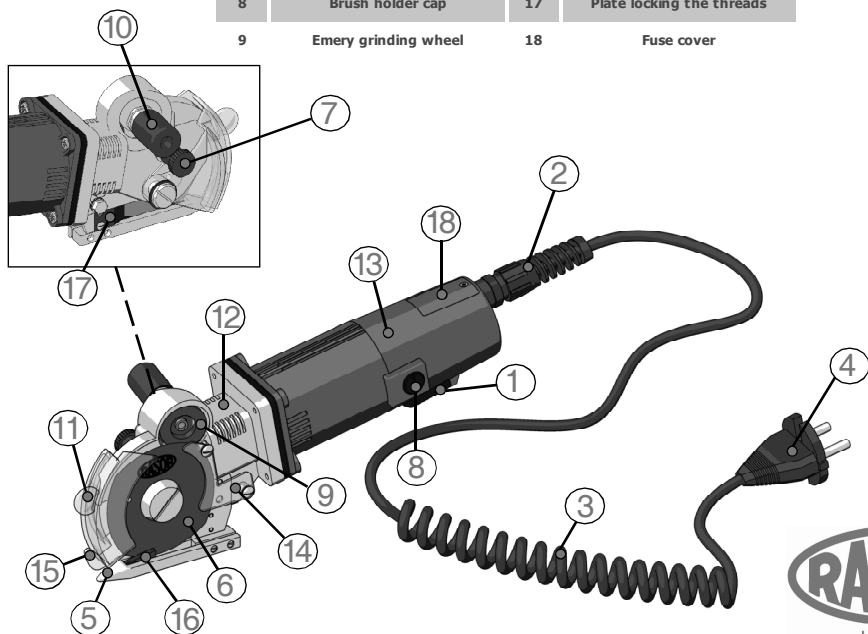

**RASOR**<sup>®</sup>

dal 1946

## 5. TECHNICAL FEATURES

Electric scissors OPTIMA 702 features	
Blade diameter	70 mm with carbide counterblade
Blade speed	750 revolutions/min
Cutting working depth	about 20 mm
Motor power	Monophase 220 V - 150 W
Max. Absorption	0.5 A
Weight (with feeding cable)	1150 g
Weight with package	2000 g
Electrical cable length	1.5 mt
Minimum luminosity for working operations	LUX 200
Vibrations at the start up	< 2.5 m/s <sup>2</sup>
Temperature	0 ~ 55°C
Humidity	10 ~ 95% without condensate

Features of the available blades	
70SHSS	HSS steel quadrangular blade Ø 70 mm
70EHSS	HSS steel hexagonal blade Ø 70 mm
70CEXT	Extra steel circular blade Ø 70 mm
70DHSS	HSS steel decagonal blade Ø 70 mm
70SHSSTF	Teflon® coated HSS steel quadrangular blade Ø 70 mm
70EHSSTF	Teflon® coated HSS steel hexagonal blade Ø 70 mm
70EMD	Integral carbide hexagonal blade Ø 70 mm

The technical data is only indicative and it can be changed without notice.

## 6. NOISE LEVEL

The maximum acoustic pressure level emitted by electric scissors OPTIMA 702 is about 60 dB (A). Noise tests have been carried out in compliance with Standard UNI EN ISO 11202:2010. The device noise levels, measured at different distances (without any sound wave filtering system), vary in the extent of few db (A).

### NOTE

It is advisable for electric scissors OPTIMA 702 owners to verify the compliance with the standard concerning safety of workers: Italian legislative decree 81/08. The use of ear protecting devices is compulsory.

## 7. FIELD OF APPLICATIONS

Electric scissors OPTIMA 702 have been designed, manufactured and assembled to cut every kind of fabrics or materials, with the exception of metal, plastic or wood, by means of rotary blades.

This equipment must not work:

- in areas prone to explosions;
- in presence of fine dust or corrosive gases;
- on wet or damp materials;
- to cut plastic, metal and wooden materials.

**It is forbidden to use electric scissors OPTIMA 702 for purposes different from the above-mentioned ones.**

## 8. USE WARNINGS

We recommend following the indications below in order to always work in safety conditions.

- All the operations must be carried out complying strictly with the safety rules of the country where the device is sold.
- It is **STRICTLY FORBIDDEN** to smoke during the installation or adjustment operations of the electric scissors.
- The Customer undertakes to comply with and make his staff observe all the rules and regulations in force concerning safety, prevention of accidents and health in the work place. Therefore, the Customer assumes the responsibility to strictly follow all the rules and regulations in force, as well as the special provisions in force in sport and public installations the Customer declares to know after receiving all the relative necessary pieces of information.
- **The electric scissors work also without their safety protective device. This protective device must NEVER be removed.**
- Always check the resistance of the material to be cut and the kind of blade which is being used.
- The Customer shall equip his own personnel with all the individual safety protections for the execution of the works, as well as with the ones which might be prescribed by the Manufacturer due to specific danger conditions of the plant or of the area where the personnel must work.
- Only one operator must use the electric scissors always standing behind the guide handle. Do not make any adjustment while the blade is working or while the electric plug is connected.
- Always pay attention to the electric cable position to prevent it from being cut or damaged by the blade.
- It is allowed to assemble electric scissors OPTIMA 702 on machines O.E.M. on condition that their original structure is not modified. Otherwise, the intervention must be certified by Rasor®.

## 9. RESIDUAL RISKS

Even though the electric scissors are safe, operators must pay attention to preserve their and other people's safety.

- ⊗ At the end of the working operations, the motor could be very hot.
- ⊗ The cutting blade can work even when the protective device is disassembled.





## 10. USE

To use the electric scissors manually, proceed as follows:

- 1) Lay the material to be cut on a table;
- 2) Connect the scissors to the power supply;
- 3) Put the material on the cutting foot;
- 4) Enable the enabling push button (see picture 3);
- 5) Push the electric scissors in the desired direction, being careful to keep the material in front of them as stretched as possible and preventing it from curling in the front part of the scissors.

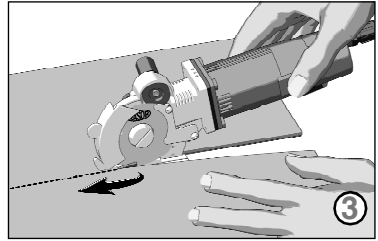

### NOTE

The thrust on the electric scissors must be as uniform as possible. To carry out linear cuts with precision (and to follow predetermined paths), we also recommend using the arrow point (see point "A" in picture 4).

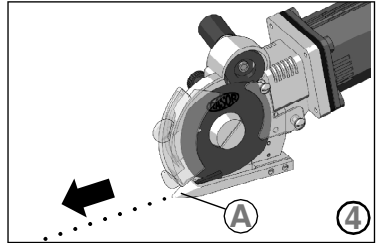

EN  
25

## 11. MOTOR FUSE REPLACEMENT

In order to replace the motor fuse, proceed as follows:

- 1) Disconnect the scissors from the power supply;
- 2) Remove the screw from the fuse cover (see point "A" picture 5);
- 3) Take out the glass fuse by means of the proper pliers supplied (see picture 6);
- 4) Verify its integrity (see picture 7) and, in case, install a new fuse checking the correct amperage;
- 5) Close the cover and tighten the screw.

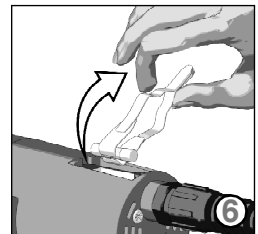
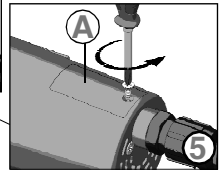
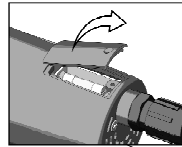

### WARNING

Never use the scissors when the fuse cover is open.  
Risk of electric shock.

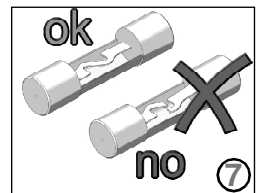

**RASOR**<sup>®</sup>

dal 1946

## 12. REPLACEMENT OF THE MOTOR BRUSHES

Electric scissors OPTIMA 702 are provided with a high power permanent magnet motor and torque. For this reason it is necessary to check periodically if the carbon brushes are worn in order not to jeopardize the motor operation and its duration period. Unscrew the caps located on the cover by means of a slotted screwdriver (see picture 8); withdraw the carbon brushes, check if they are worn and, if needed, replace them. Assemble the two caps again, being careful to hold them in a perfectly vertical position, and screw them completely only when you are sure that the mouth is the correct one.

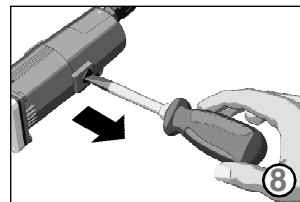

**Note:** The brush must be inserted with its black part directed inside the motor.

**Note:** A slight difference in the wear of the two brushes is absolutely normal in a permanent magnet motor. Nevertheless, in the event that the difference between them is excessive, it is necessary to apply to a technical center for a complete check of the fixture.

### **WARNING**

Before carrying out any operations on the electric scissors, make sure that the supply plug is not connected to the mains.

## 13. BLADE SHARPENING

After many hours of a continuative use of the electric scissors or if they are not able to cut anymore, it is necessary to sharp the blade. To carry out this operation, start the blade and press sharpening button "1" for 3-4 seconds (as shown in picture 9). Repeat this operation 2-3 times.

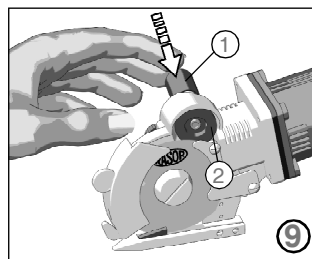

If the sharpening process should be ineffective, check the wear of the emery grinding wheel "2" (see picture 9). If wheel "2" is too worn or dirty, replace it by removing the blade with the proper tool.

### **WARNING**

The sharpening button can be only pressed if the front mobile protection is completely lowered.

## 14. LUBRICATION

Every 3-4 days of use, it is necessary to lubricate the pair of gears. To carry out this operation, remove protective plug "A" located on the head of the electric scissors and fill it with the supplied lubricating grease. Screw plug "A" again few turns. Screw plug "A" some turns every 2-3 working hours (see picture 10). Fill the plug again, once it has been tightened.

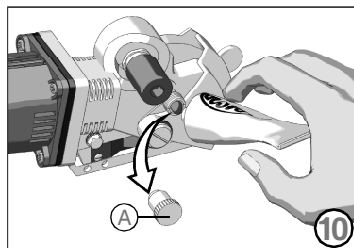

### **WARNING**

The blade must never be dirty with grease or oil.



## 15. BLADE REPLACEMENT

If the blade is no more able to cut (even after repeating the sharpening operation several times), it is necessary to replace it. In order to carry out this operation, use butterfly wrench "1" and drift "3" locking the blade (shown in picture 11).

In order to replace the blade, proceed as follows:

- 1) Use some protective gloves in compliance with Italian Legislative Decree 81/08;
- 2) Remove the safety back fixed protection "A" (see picture 12), by unscrewing the two slotted screws "C" by means of a screwdriver (not supplied by the manufacturer) as shown in picture 13.

Remove the safety front mobile protection "B" (see picture 12) by unscrewing pin "D" and by extracting the two washers "E" as shown in picture 13.

- 3) Insert drift "3" (see picture 11) into hole "F" in order to lock the blade (the hole in the blade must correspond to the hole in the structure).
- 4) Use butterfly wrench "1" in order to unscrew nut "G" (see picture 14) and remove blade "H" (see picture 15).
- 5) Replace the worn blade with the new one "2", being careful to center the blade on the shaft, in the correct position, and remember to assemble it with the side with the writing **RASOR** positioned towards the external side of the electric scissors.
- 6) Assemble all the components again and carry out some cutting and sharpening tests.

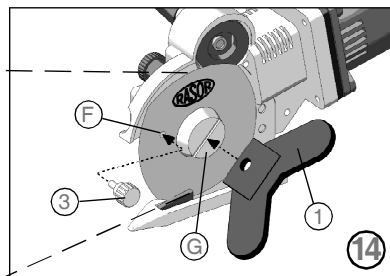
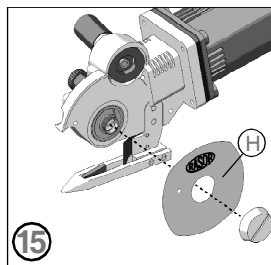
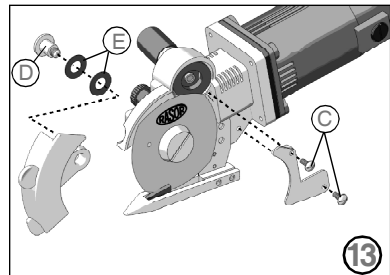
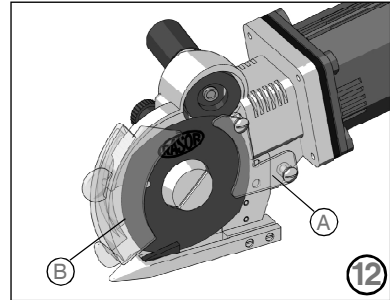
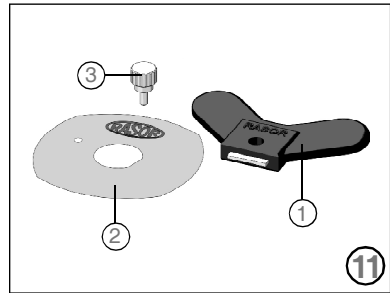

## 16. TROUBLESHOOTING

EN  
28

✘ PROBLEM	⇒ SOLUTION
The fabric is not cut or it gets stuck between the blade and the counterblade	Check that blade and counterblade contact with each other
	Check the kind of fabric
	Sharpen the blade
	Check the fabric thickness
	Check the compatibility between blade and fabric
	Make sure that the motor turns correctly
The electric scissors are noisy	Reduce the feeding speed
	Check the counterblade integrity
	Carry out the lubrication
The scissors start slowly, work intermittently or do not start	Disassemble the blade and remove the material residues
	Check the wear of the pair of gears
	Check the protection fuse with a tester
	Check the electric connections
	Check the motor brushes
	Check the feeding cable

## 17. SPARE PARTS / EXPLODED VIEW

CODE	DESCRIPTION	CODE	DESCRIPTION	CODE	DESCRIPTION	CODE	DESCRIPTION
705H5	QUADRANGULAR BLADE Ø 70 mm, H.S.S. STEEL	F 5057	DRIFT LOCKING THE BLADE	F 7028	CLOSING RING	F 7054/1	TOOTHED WASHER
F 5004	PUSH BUTTON SPRING	F 5059	BLADE ASSEMBLY/DISASSEMBLY WRENCH	F 7029	WORM SCREW BEARING mm 10x2,2x6	F 7055	WIDIA COUNTERBLADE WITH SPRING
F 5006	SINGLE-POLE ENABLING PUSH BUTTON	F 506002	BRUSH CONTACT SPRING	F 7030	WORM SCREW - MOD. 1	F 7056	COUNTERBLADE FASTENING SCREW
F 5007L	LONG MOTOR CARBON BRUSH	F 5061L	CONTACT FASTENING SCREW	F 7030CPL	COMPLETE WORM SCREW - MOD. 1	F 7061	SUB-BLADE RING
F 5008	SWITCH FIXING PLATE	F 5062	CARBON BRUSH HOLDER	F 7031	ANTIFRICTION BUSHING	FRN702	OPTIMA 702 COMPLETE ACCESSORIES SET
F 5009	CABLE FIXING U-BOLT	F 5063	BRUSH HOLDER CAP	F 7032	SNAP RING	SW108600	EMERY GRINDING WHEEL: MEDIUM GRAIN
F 5009/1	U-BOLT FASTENING SCREW	F 7001	SPIRAL FEEDING CABLE	F 7033	CORRUGATED THRUST WASHER	SW1086CPL	COMPLETE EMERY GRINDING WHEEL UNIT
F 501101	RIGHT CONTACT TERMINAL	F 7002	SPIRAL CABLE GLAND	F 7036	THRUST WASHER	SW108700	EMERY GRINDING WHEEL PIN
F 501102	LEFT CONTACT TERMINAL	F 7005	PUSH BUTTON LEVER	F 7037	RING GEAR	SW108800	EMERY GRINDING WHEEL SPRING Ø 11 mm
F 5012	BEARING FIXING PLATE	F 7006	EMERY GRINDING WHEEL CAP	F 7038	RING GEAR BEARING	SW108900	SCREWED BUSH
F 5013	MOTOR CAP FASTENING SCREW	F 7018	MOTOR FRAME WITH MAGNETS	F 7039CPL	COMPLETE RING GEAR	SW109000	EMERY GRINDING WHEEL SPRING Ø 6 mm
F 5014	SWITCH PLATE FASTENING SCREW	F 701901CPL	COMPLETE ROTOR 110 V	F 7042	BLADE FIXING RING NUT	SW109200	FRONT PROTECTION GUARD CAP FASTENING SCREW
F 5015	BEARING PLATE FASTENING SCREW	F 7019CPL	COMPLETE ROTOR 220 V	F 7043	FRONT PROTECTION GUARD	SW109300	STEEL WASHER
F 5017	MOTOR BEARING mm 5x16x5	F 70202	FUSE COVER	F 7043CPL	FRONT PROTECTION SET	T104500	EMERY GRINDING WHEEL CAP FASTENING SCREW
F 5018/1	PERMANENT MAGNET COUPLE	F 70203	MOTOR CAP WITH HOLE	F 7044	BACK PROTECTION GUARD FASTENING SCREW	T104501	PAIR OF CONVEXED WASHERS
F 5020	FAN	F 70203CPL	MOTOR CAP WITH DOOR AND SCREW	F 7045	BACK PROTECTION GUARD	T104700	GREASER CAP
F 5021	MOTOR BEARING 6x19x6	F 70210	ELECTRONIC CIRCUIT WITH FUSE	F 7045CPL	BACK PROTECTION SET	T104800	GREASER
F 5022	BEARING FIXING SPRING	F 70210F01	FUSE 1.25 A	F 7049	PLATE LOCKING THE THREADS	T106000	RING GEAR LEFT FASTENING SCREW
F 5023	ADJUSTMENT RING	F 7024	CLOSING FLANGE	F 7050	PLATE LOCKING THE THREADS FASTENING SCREW	T107900	LUBRICATING GREASE
F 5025	MOTOR COVER FASTENING SCREW	F 7026	COMPLETE MOTOR SUPPORT	F 7053	WELD FOOT		
F 50304	FUSE COVER FASTENING SCREW	F 7027	JOINT	F 7054	FOOT FASTENING SCREW		



dal 1946

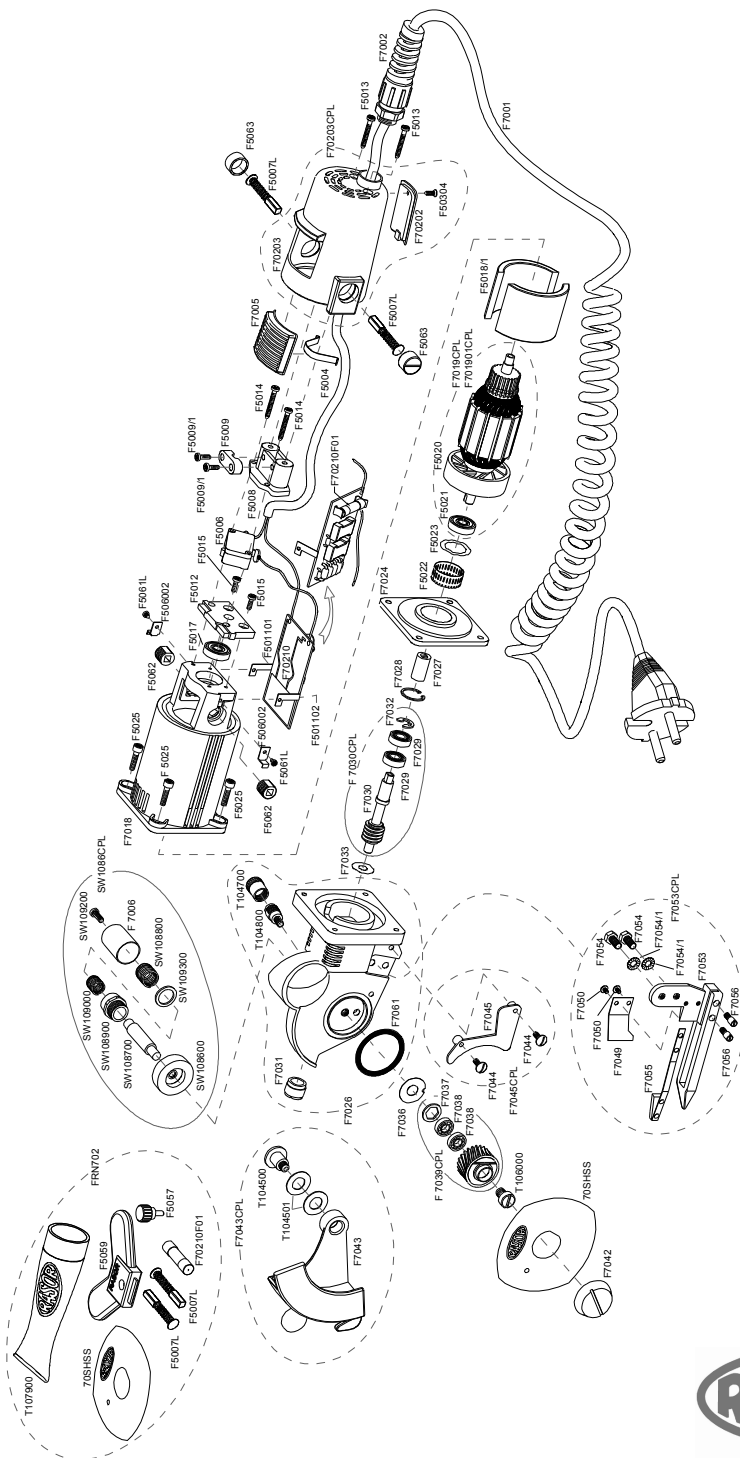

dal 1946

---

## WARRANTY

Rasor® Elettromeccanica S.r.l. electric scissors have a 12 month warranty from the date indicated on the last page of this manual, except in case of different written agreements. The warranty covers all manufacturing and material defects. Replacement and repair operations are covered only if carried out by our company and at our workshop. If in-warranty goods need to be repaired, **the customer must always send the complete machine to Rasor®.**

### **Single units will not be repaired under warranty.**

The material to be repaired must be sent CARRIAGE FREE.

Once the equipment has been repaired, it will be sent CARRIAGE FORWARD to the customer. The warranty covers neither technicians' intervention on the site where the electric scissors are used nor their disassembly.

If for practical reasons, one of our technicians is sent to the premises, the customer will be charged the costs plus the travelling expenses.

The warranty does not include:

- ☞ failure caused by wrong use or assembly,
- ☞ failure caused by external agents,
- ☞ failure caused by lack of maintenance or negligence;
- ☞ blades and parts subject to wear.

### WARRANTY FORFEITURE:

- ☞ In case of arrearage or other breaches of contract,
- ☞ Whenever changes or repairs are carried out on our electric scissors without our prior authorization,
- ☞ Whenever the serial number is tampered with or cancelled,
- ☞ Whenever the damage is caused by improper use, bad treatment, bumps, falls and other causes not due to normal working conditions,
- ☞ Whenever the unit seems tampered with, dismantled or previously repaired by unauthorized staff,
- ☞ In case the electric scissors are used for purposes that are different from the ones described in this manual.

All repair operations carried out under warranty do not interrupt its duration.

**All disputes will be settled in the court of justice of Milan (Italy).**

We thank you in advance for the attention you will pay to this manual and we invite you to inform us of any change you deem necessary to improve it and make it more complete.

---

DECLARATION OF CONFORMITY



We hereby certify that the device specified hereunder complies to the requirements of Machinery Directive 2006/42/EC, Electromagnetic Compatibility 2004/108/EC and CEI EN 60204-1, Directive 2002/44/EC and to technical rulings UNI EN 414:2002, UNI EN ISO 12100:2010.

Noise tests have been carried out according to UNI EN ISO 11202:2010 Standards.

Electric scissors OPTIMA 702 have been produced according to workmanlike standards.

We declare that the above-mentioned goods comply with the standards in force concerning safety and hygiene at work that can be applied to the material itself according to the Italian legislative decree No. 81/08 (local law); the above-mentioned goods are not included in the goods indicated in annex IV of Machinery Directive 2006/42/EC.

- 1. Category: **ELECTRIC SCISSORS**
- 2. Manufacturer: **RASOR® ELETTROMECCANICA S.R.L.**
- 3. Type: **OPTIMA 702**
- 4. Serial number: .....
- 5. Year of manufacture: .....
- 6. Country of manufacture: **ITALY**
- 7. Additional information: .....

**RASOR ELETTROMECCANICA S.R.L.**  
*CUTTING EQUIPMENTS*

Warranty expiry:  
12 months from invoice date or receipt

  
\_\_\_\_\_  
(Signature)



